



Installation instructions for PZ4AL- 00771- 00

LEXUS GS 300, GS450H

Under Run Protective Shield engine bay



Model Year:	GS 300 - 2005	GS450H - 2005
Vehicle Code:	GRS190L-BETQHW	GWS191L-BEXQHW
Part Number:	PZ4AL- 00771- 00	PZ4AL- 00771- 00
 Weight:	13,3 kg	13,3 kg
 Installation Time:	30 min	30 min
Manual reference number:	AIM 002 049-0	AIM 002 049-0

Part number: PZ4AL - 00771 - 00

A

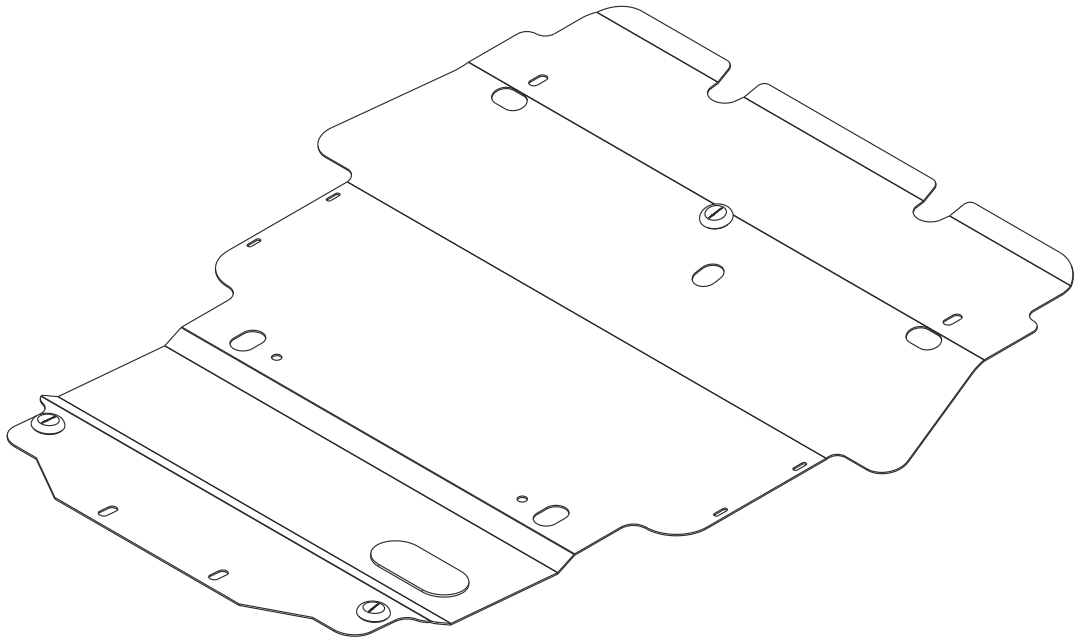

PZ4AL - 00771 - 60

B

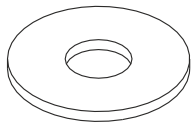

4 x Ø10

C

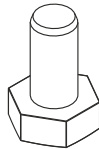

4x M10X30

D

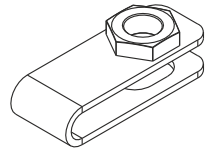

4 x

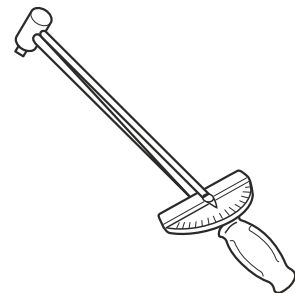
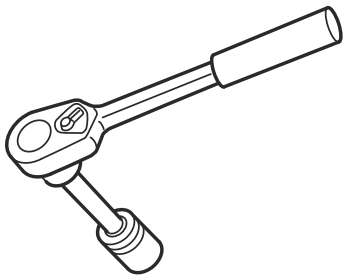

1

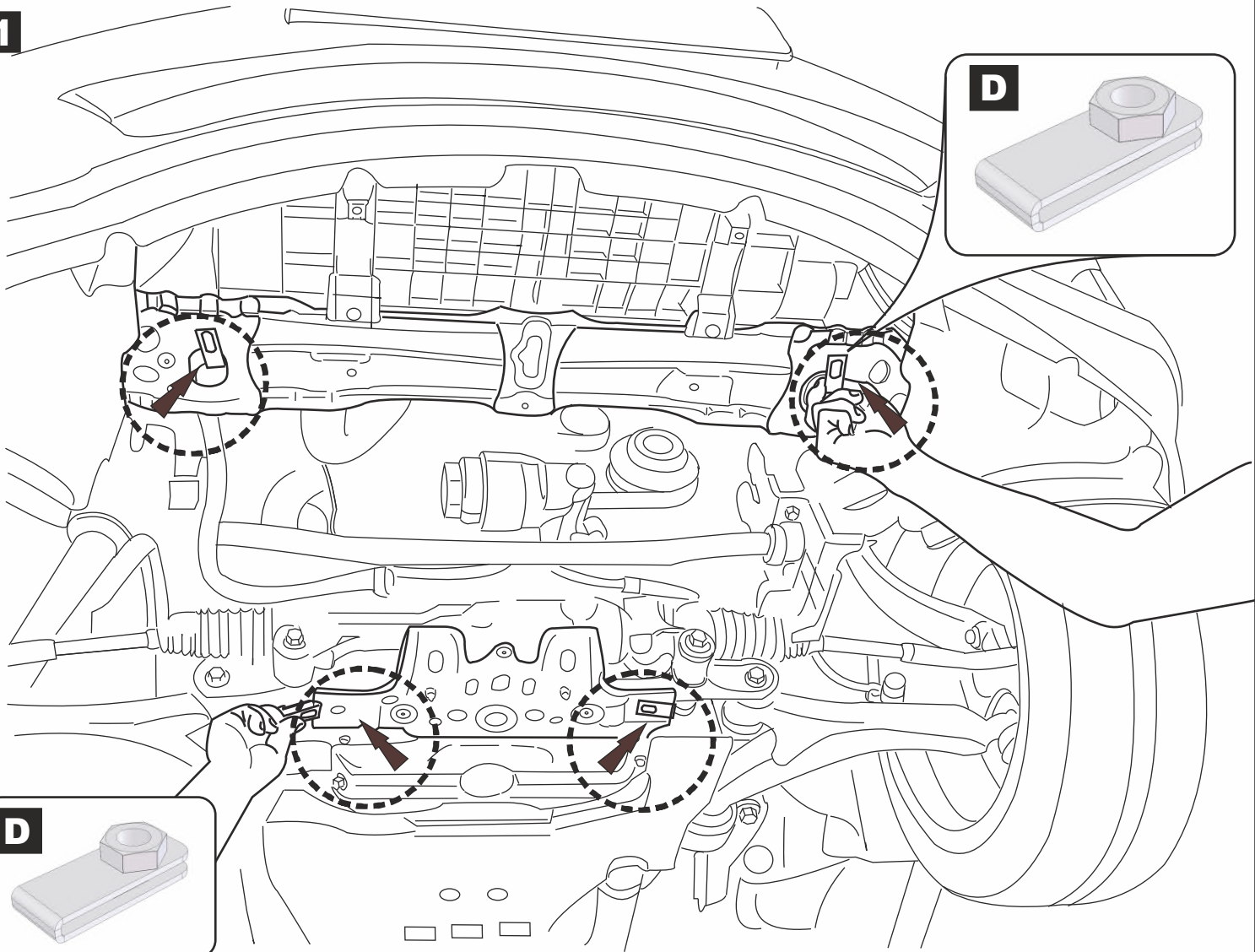
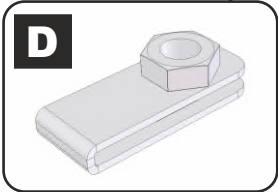
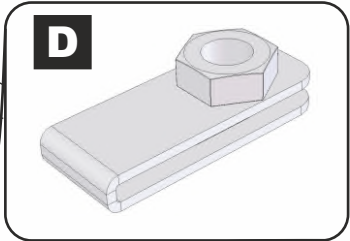

2

